



Tube Power Amplifier



MC2301 Owner's Manual

The lightning flash with arrowhead, within an equilateral triangle, is intended to alert the user to the presence of uninsulated “dangerous voltage” within the product’s enclosure that may be of sufficient magnitude to constitute a risk of electric shock to persons.



AVIS RISQUE DE CHOC ELECTRIQUE - NE PAS OUVRIR.

The exclamation point within an equilateral triangle is intended to alert the user to the presence of important operating and maintenance (servicing) instructions in the literature accompanying the appliance.

WARNING - TO REDUCE RISK OF FIRE OR ELECTRICAL SHOCK, DO NOT EXPOSE THIS EQUIPMENT TO RAIN OR MOISTURE.

NO USER-SERVICEABLE PARTS INSIDE. REFER SERVICING TO QUALIFIED PERSONNEL.

To prevent the risk of electric shock, do not remove cover or back. No user-serviceable parts inside.

IMPORTANT SAFETY INSTRUCTIONS!

PLEASE READ THEM BEFORE OPERATING THIS EQUIPMENT.

1. Read these instructions.
2. Keep these instructions.
3. Heed all warnings.
4. Follow all instructions.
5. Do not use this apparatus near water.
6. Clean only with a dry cloth.
7. Do not block any ventilation openings. Install in accordance with the manufacturer’s instructions.
8. Do not install near any heat sources such as radiators, heat registers, stoves, or other apparatus (including amplifiers) that produce heat.
9. Do not defeat the safety purpose of the polarized or grounding-type plug. A polarized plug has two blades with one wider than the other. A grounding type plug has two blades and a third grounding prong. The wide blade or the third prong are provided for your safety. If the provided plug does not fit into your outlet, consult an electrician for replacement of the obsolete outlet.
10. Protect the power cord from being walked on or pinched particularly at plugs, convenience receptacles, and the point where they exit from the apparatus.
11. Only use attachments/accessories specified by the manufacturer.
12. Use only with the cart, stand, tripod, bracket, or table specified by the manufacturer, or sold with the apparatus. When a cart is used, use caution when moving the cart/apparatus combination to avoid injury from tip-over. 
13. Unplug this apparatus during lightning storms or when unused for long periods of time.
14. Refer all servicing to qualified service personnel. Servicing is required when the apparatus has been damaged in any way, such as power-supply cord or plug is damaged, liquid has been spilled or objects have fallen into the apparatus, the apparatus has been exposed to rain or moisture, does not operate normally, or has been dropped.
15. Do not expose this equipment to dripping or splashing and ensure that no objects filled with liquids, such as vases, are placed on the equipment.
16. To completely disconnect this equipment from the a.c. mains, disconnect the power supply cord plug from the a.c. receptacle.
17. The mains plug of the power supply cord shall remain readily operable.
18. Do not expose batteries to excessive heat such as sunshine, fire or the like.

IMPORTANT!

**INSTRUCTIONS FOR REMOVAL
OF FOAM INSERTS OVER THE
VACUUM TUBES PRIOR TO
CONNECTING THE A.C. POWER
SUPPLY CORD, START ON THE
NEXT PAGE.**





Unpacking the MC2301

Caution: To prevent damage to the MC2301 Tubes during shipping, there is a special foam insert surrounding the Tubes located on both sides of the Power Amplifier.

BOTH Foam Inserts must be removed from the MC2301 before connecting the AC Power Supply Cord to the power amplifier.

Failure to do so has the potential of a Fire Hazard, resulting in damage to the MC2301 and the surrounding environment.

Follow the instructions below for removal of the packing foam before connecting the AC Power Supply Cord to the MC2301.

In order to remove the foam inserts surrounding the tubes on the MC2301, it is necessary to temporarily remove the two Tube Covers. After the foam inserts are removed, the Tube Covers are re-installed and should not be removed. The covers provide protection from the hazardous voltages inside the MC2301. The MC2301 has no user serviceable parts, including the tubes. If repairs are needed they must be performed by an authorized McIntosh Service Agency.

1. Orient the MC2301 so the Front Panel is facing you and remove the Warning Sheet. Refer to figure 1.
2. Using a Philips Head #2 screw driver, remove the two chassis screws securing the Tube Cover to the chassis on both sides of the MC2301. Refer to figure 2.
3. Carefully lift up and remove the Tube Cover from each side of the MC2301. Refer to figure 3.
4. Place the Tube Covers and the previously removed chassis screws in a safe location, as the Tube Covers will be reinstalled.
5. Carefully lift up and remove the Foam Insert from both sides the MC2301 exposing the Tubes. Refer to figures 4 and 5.

6. Carefully reinstall the previously removed Tube Covers and chassis screws on both sides of the MC2301. Make sure the metal tabs located on the bottom of the Tube Cover are inserted into the chassis slots. Refer to figures 6, 7 and 8.

Note: Only use the chassis screws supplied with the MC2301. If you can not find the chassis screws, contact the McIntosh Parts Department for replacements.

7. Save the two Foam Inserts and Warning Sheet with the MC2301 Shipping Carton for possible further use.

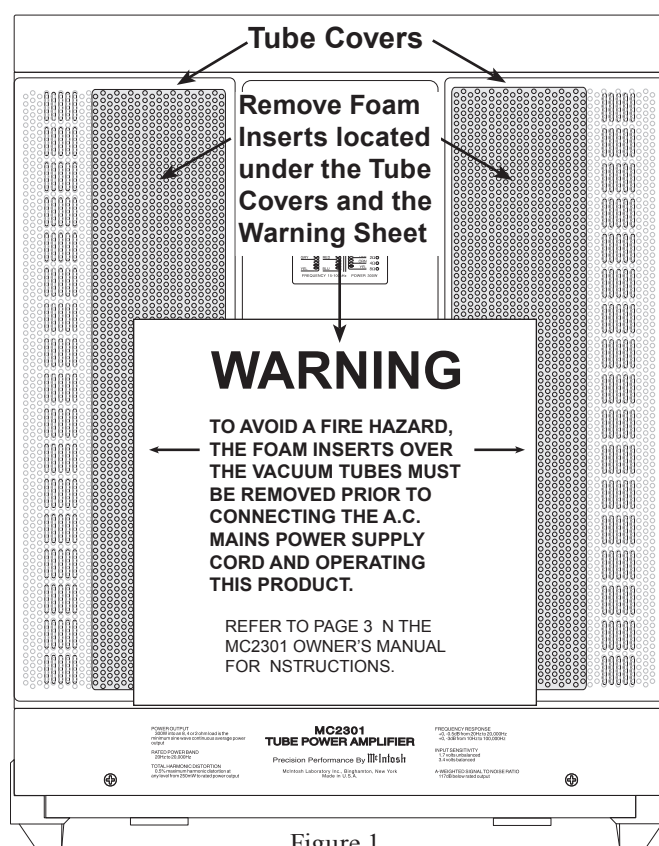

Figure 1

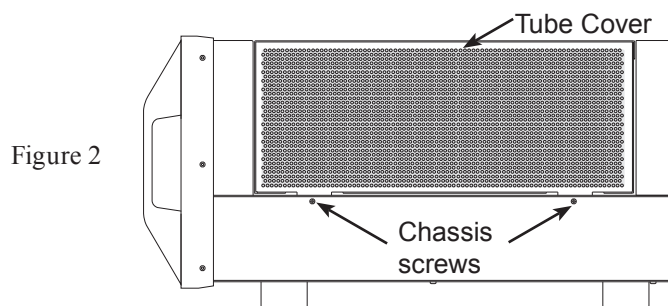

Figure 2

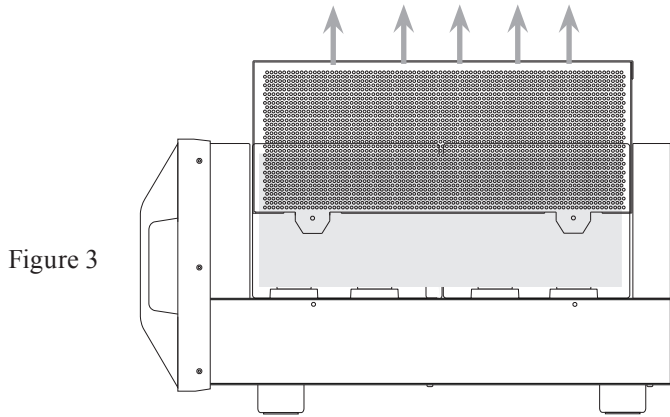

Figure 3

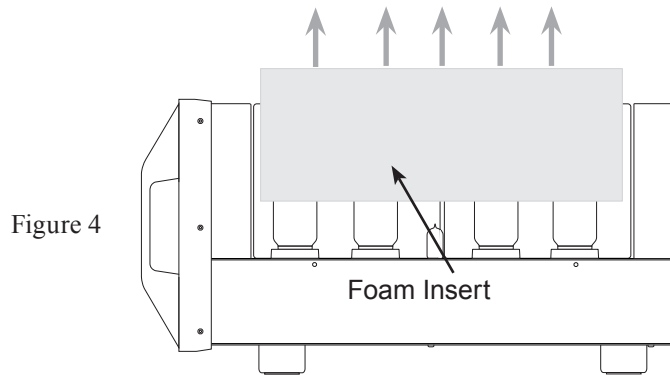

Figure 4

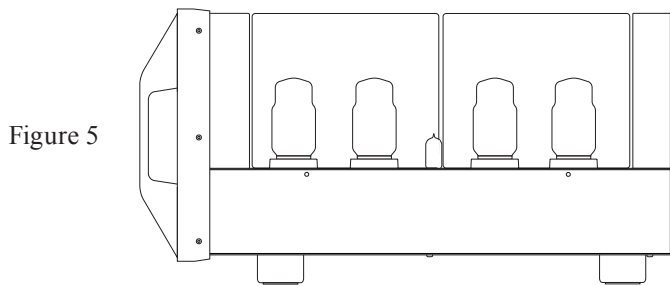

Figure 5

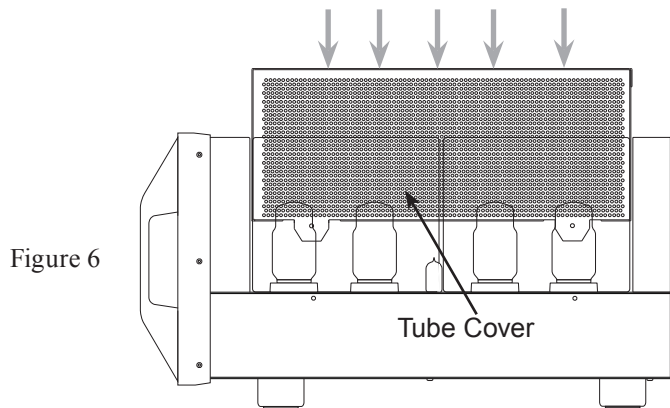

Figure 6

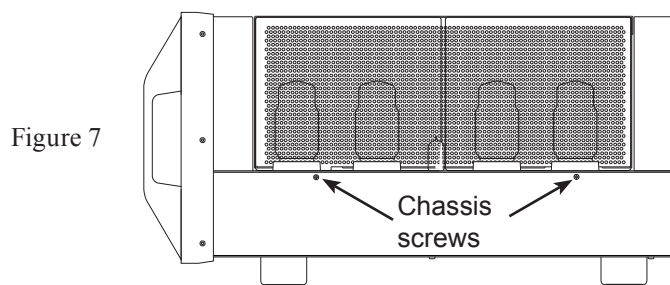

Figure 7

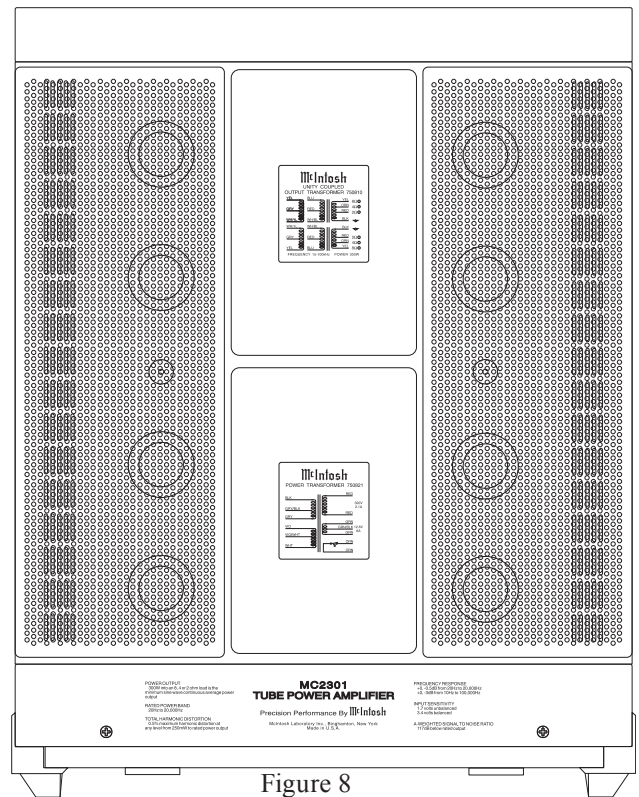

Figure 8

Ventilation

Adequate ventilation extends the trouble free life of the MC2301. Always allow air to flow through the ventilation holes on the bottom of the amplifier and a means for the warm air to escape at the top. Refer to figure 9 and the information on the next page for placement and installation of the MC2301.

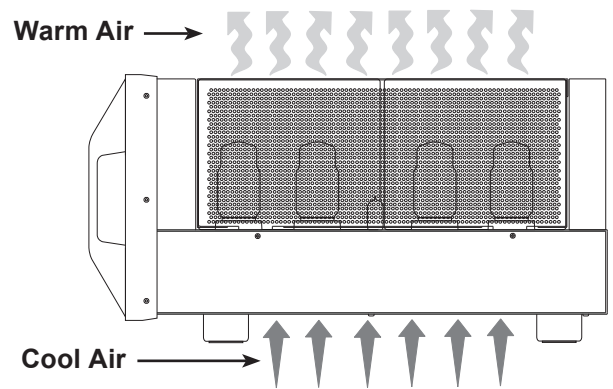

Figure 9



Thank You

Your decision to own this McIntosh MC2301 Tube Power Amplifier ranks you at the very top among discriminating music listeners. You now have “The Best.” The McIntosh dedication to “Quality,” is assurance that you will receive many years of musical enjoyment from this unit.

Please take a short time to read the information in this manual. We want you to be as familiar as possible with all the features and functions of your new McIntosh.

Please Take A Moment

The serial number, purchase date and McIntosh Dealer name are important to you for possible insurance claim or future service. The spaces below have been provided for you to record that information:

Serial Number: _____

Purchase Date: _____

Dealer Name: _____

Technical Assistance

If at any time you have questions about your McIntosh product, contact your McIntosh Dealer who is familiar with your McIntosh equipment and any other brands that may be part of your system. If you or your Dealer wish additional help concerning a suspected problem, you can receive technical assistance for all McIntosh products at:

McIntosh Laboratory, Inc.
2 Chambers Street
Binghamton, New York 13903
Phone: 607-723-1545
Fax: 607-724-0549

Customer Service

If it is determined that your McIntosh product is in need of repair, you can return it to your Dealer. You can also return it to the McIntosh Laboratory Service Department. For assistance on factory repair return procedure, contact the McIntosh Service Department at:

McIntosh Laboratory, Inc.
2 Chambers Street
Binghamton, New York 13903
Phone: 607-723-3515
Fax: 607-723-1917

Table of Contents

Safety Instructions.....	2-3
Unpacking the MC2301.....	4-5
Thank You and Please Take a Moment.....	6
Technical Assistance and Customer Service.....	6
Table of Contents.....	6
General Information.....	6
Connector Information.....	7
Introduction.....	7
Performance Features.....	7
Dimensions.....	8
Installation.....	9
Rear Panel Connections and Switch.....	11
How to Connect.....	12-13
How to Connect for Bi-Amp.....	14-15
Front Panel Displays and Controls.....	16
How to Operate.....	17
Technical Description.....	18-21
Specifications.....	22
Packing Instruction.....	23

General Information

Caution: The MC2301 Amplifier weight is 116 pounds (52.6 kilograms). It requires two or more persons to safely handle when moving the amplifier.

1. The following Connecting Cable is available from the McIntosh Parts Department:
Power Control Cable Part No. 170-202
Six foot, 2 conductor shielded, with two 1/8 inch stereo mini phone plugs.
2. For additional connection information, refer to the owner's manual(s) for any component(s) connected to the MC2301.
3. The MC2301 mutes the speaker output for approximately fifteen seconds when first turned on.
4. The MC2301 incorporates the very latest in Fully Balanced Circuitry. As a result, the Loudspeaker ⊖ Negative Connections are above chassis ground. Do not combine any connections together, ground them or connect with another MC2301 or other Power Amplifier.

Connector and Cable Information

XLR Connectors

Below is the Pin configuration for the XLR Balanced Input, Input/Output Connectors on the MC2301. Refer to the diagram for connection:

- PIN 1: Shield/Ground
- PIN 2: + Output
- PIN 3: - Output

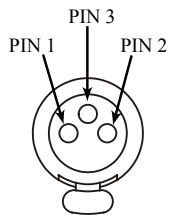

Power Control Connector

The MC2301 Power Control Input receives an On/Off signal from +5 to +12 volts. The Power Control Output will in turn provide a +12 volt Output Signal with a current up to 20mA. An additional connection is for controlling the illumination of the MC2301 Power Output Meter. The 1/8 inch stereo mini phone plug connects to a McIntosh A/V Control Center Power Control Output.

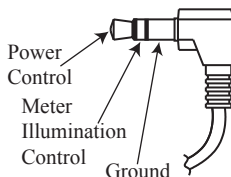

Note: The Power Control Connecting Cable is available from the McIntosh Parts Department:

Data and Power Control Cable Part No. 170-202

Six foot, shielded 2 conductor, with 1/8 inch stereo mini phone plugs on each end.

Introduction

Now you can take advantage of traditional McIntosh standards of excellence in the MC2301 Tube Power Amplifier. The 300 watt power output will drive any high quality Loudspeaker System to its ultimate performance. The MC2301 reproduction is sonically transparent and absolutely accurate. The McIntosh Sound is “The Sound of the Music Itself.”

Performance Features

• Power Output

The MC2301 is a Tube Power Amplifier with a capability of 300 watts into 2, 4 or 8 ohm speakers with less than 0.5% distortion.

• Full Balanced Unity Coupled Circuitry

The MC2301 is fully balanced from input to output. It consists of two matched Power Amplifiers operating in push-pull using the famous McIntosh Patented Unity Coupled Circuit. The circuit outputs are combined in a dual core McIntosh Multifilar Wound Output Transformer for low distortion, extended frequency response and cool operating output tubes.

• Balanced and Unbalanced Input

Balanced connections guard against induced noise and allow long cable runs without compromising sound quality.

• Sentry Monitor Tube and Thermal Protection

McIntosh Sentry Monitor Tube Protection Circuits ensure the MC2301 will have a long and trouble free operating life. Built-in Thermal Protection Circuits guard against overheating.

• Illuminated Power Meter

The Illuminated Power Output Watt Meter on the MC2301 is peak responding, and indicates the true power output of the amplifier. The Peak Watt Hold Mode allows the meter to temporarily stay at the highest power output and then slowly decay. The Front Panel Meter Illumination may be switched Off at any time.

• Gold Plated Connectors and Tube Socket Contacts

Gold Plated Input Jacks and Output Binding Posts provide trouble free connections. Ceramic tube sockets with gold plated contacts provide protection from atmospheric contamination. Output Tube Sockets include Air-Pipe cooling at their bases.

• Special Power Supply

A regulated Power Supply, a very large core Power Transformer and large capacitors ensure stable noise free operation even though the power line varies.

• Fiber Optic Solid State Front Panel Illumination

The even Illumination of the Front Panel is accomplished by the combination of custom designed Fiber Optic Light Diffusers and extra long life Light Emitting Diodes (LEDs).

• Glass Front Panel and Super Mirror Chassis Finish

The famous McIntosh Illuminated Glass Front Panel and the Stainless Steel Chassis with Super Mirror Finish ensure the pristine beauty of the MC2301 will be retained for many years.



Dimensions

The following dimensions can assist in determining the best location for your MC2301. There is additional information on page 9 pertaining to installing the MC2301 into cabinets.

Front View of the MC2301

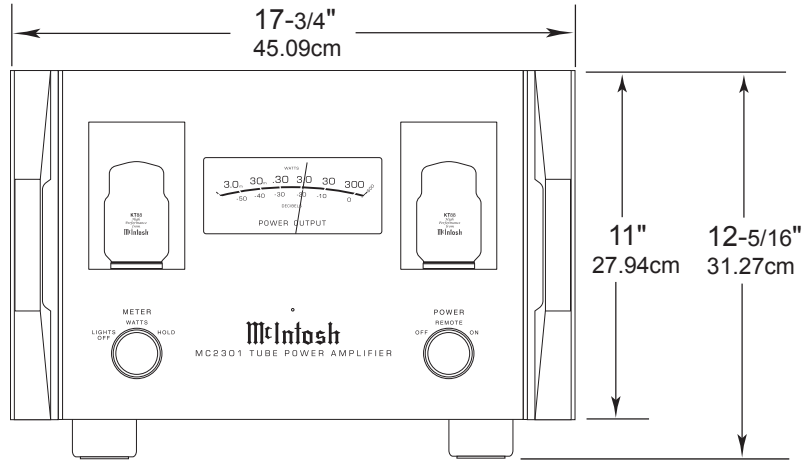

Rear View of the MC2301

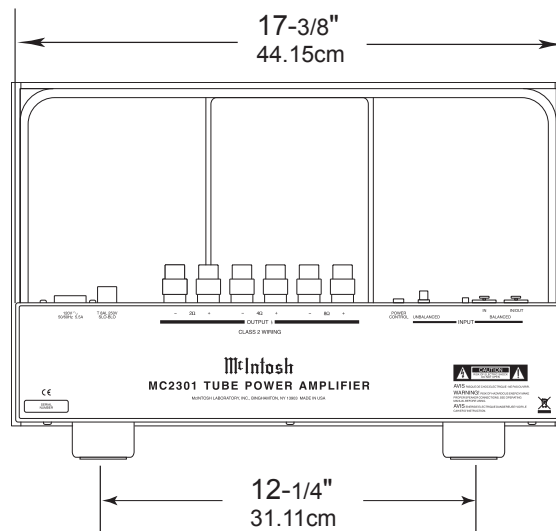

Side View of the MC2301

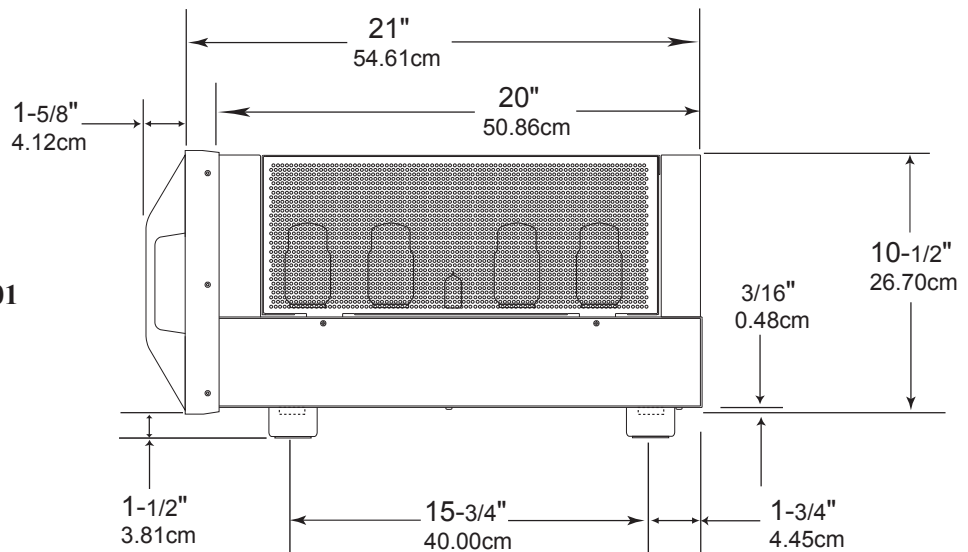

Installation

The MC2301 can be placed upright on a table or shelf, standing on its four feet. It also can be custom installed in a piece of furniture or cabinet of your choice. The four feet may be removed from the bottom of the MC2301 when it is custom installed as outlined below. The four feet together with the mounting screws should be retained for possible future use if the MC2301 is removed from the custom installation and used free standing. The required panel cutout, ventilation cutout and unit dimensions are shown.

Always provide adequate ventilation for your MC2301. Cool operation ensures the longest possible operating life for any electronic instrument. Do not install the MC2301 directly above a heat generating component such as a high powered amplifier. If all the components are installed in a single cabinet, a quiet running ventilation fan can be a definite asset in maintaining all the system components at the coolest possible operating temperature.

A custom cabinet installation should provide the following minimum spacing dimensions for cool operation.

Allow at least 12 inches (30.48cm) above the top, 2 inches (5.08cm) below the bottom and 4 inches (10.16cm) on each side of the Power Amplifier, so that airflow is not obstructed. Allow 22 inches (55.88cm) depth behind the front panel. Allow 1-5/8 inch (4.12cm) in front of the mounting panel¹

for clearance. Be sure to cut out a ventilation hole in the mounting shelf according to the dimensions in the drawing.

¹ When the MC2301 is installed together with other McIntosh Components, check clearances on all components before proceeding.

MC2301 Front Panel Custom Cabinet Cutout

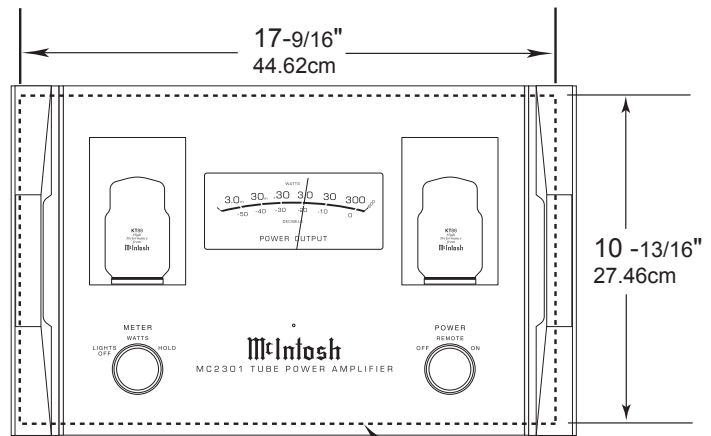

MC2301 Side View in Custom Cabinet

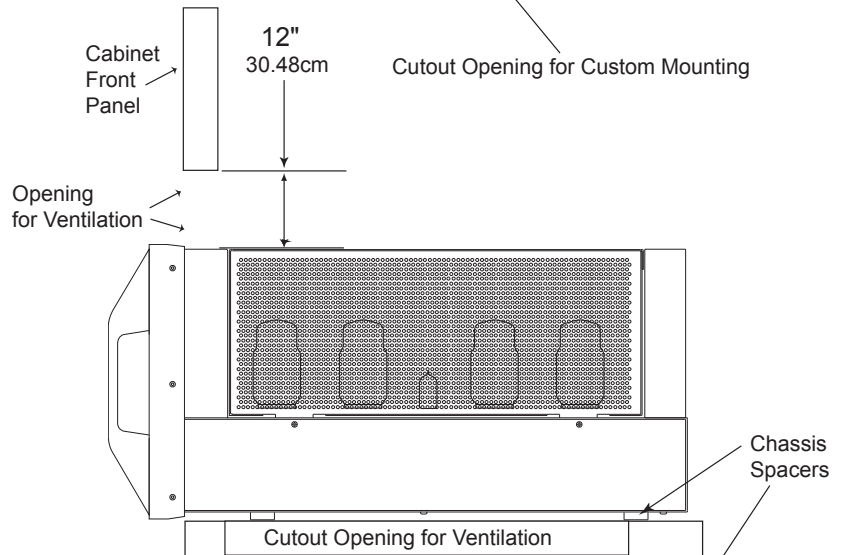

MC2301 Bottom View in Custom Cabinet

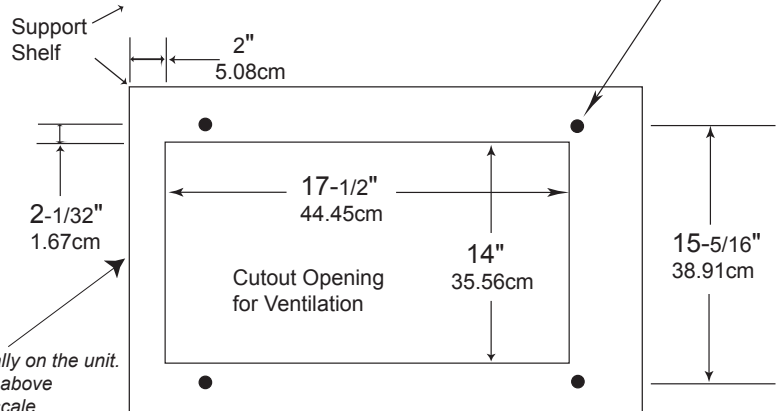

Note: Center the cutout horizontally on the unit. For purposes of clarity, the above illustration is not drawn to scale.

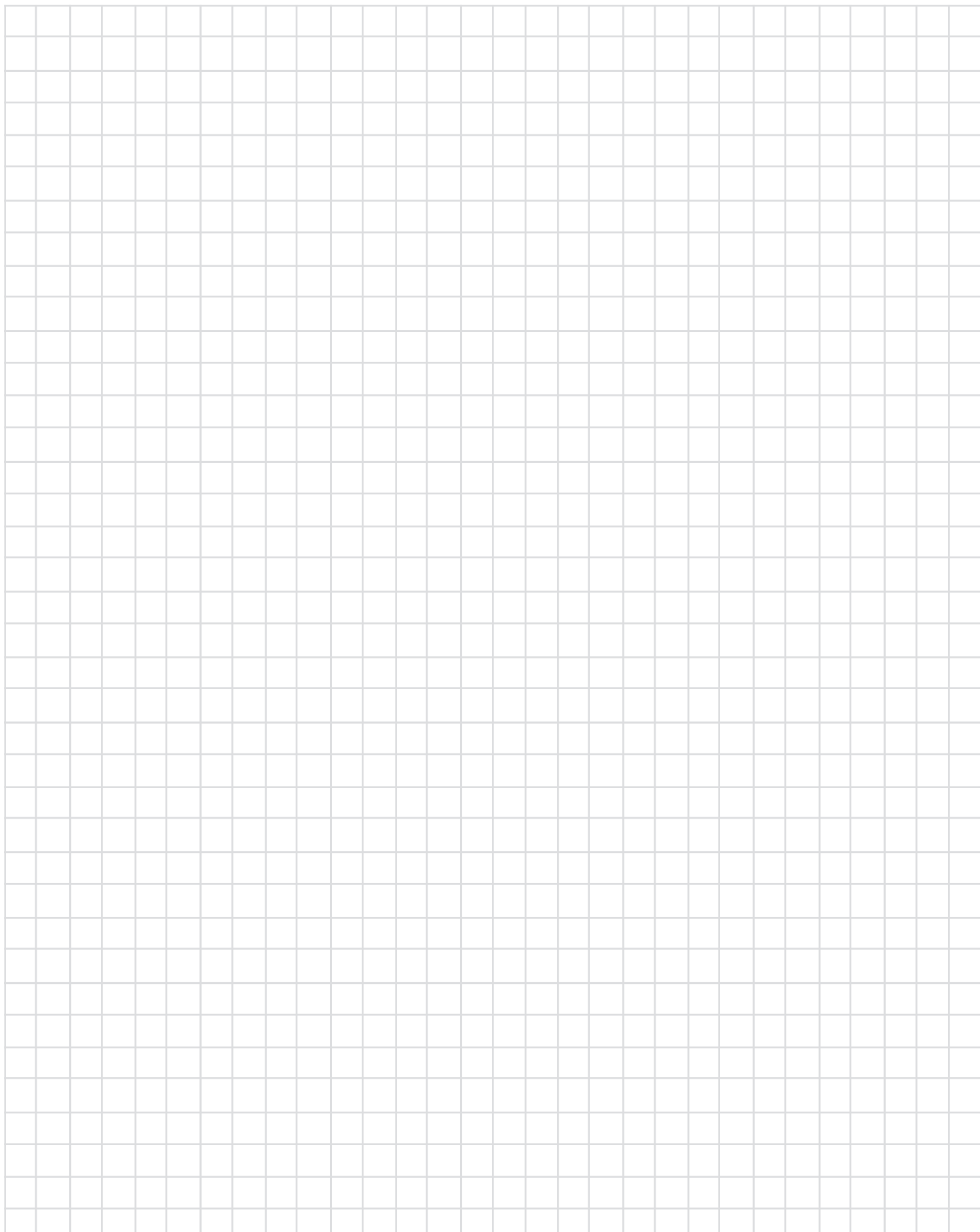

Rear Panel Connections and Switch

Connect the MC2301 power cord to a live AC outlet. Refer to the rear panel to determine the correct voltage

POWER CONTROL IN receives a turn On/Off signal from a McIntosh component and the POWER CONTROL OUT sends a turn On/Off signal to the next McIntosh Component

BALANCED INPut¹ / OUTPut for an audio cable from a Pre-amplifier output or to connect an audio cable on to the next Power Amplifier input

Main Fuse holder, refer to information on the back panel of your MC2301 to determine the correct fuse size and rating

INPUT MODE switch selects between balanced or unbalanced input

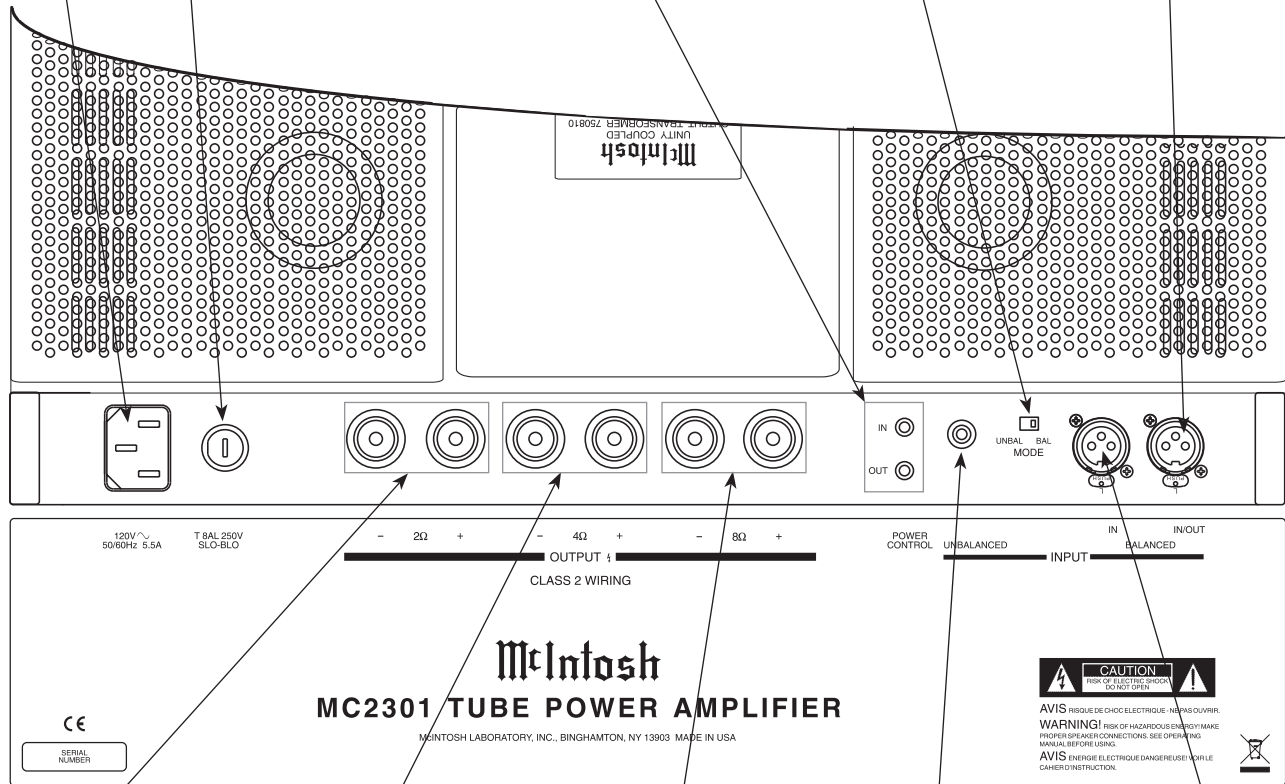

OUTPUT Connections for 2 ohm Loudspeaker

OUTPUT Connections for 4 ohm Loudspeaker

OUTPUT Connections for 8 ohm Loudspeaker

BALANCED INPUT for an audio cable from a Preamplifier or A/V Control Center audio output

Caution: The Loudspeaker ⊖ Negative Connections are above chassis ground. Do not combine any connections together, ground them or connect with another MC2301 or other Power Amplifier.

UNBALANCED INPUT for an audio cable from a Preamplifier or A/V Control Center audio output

¹ This Balanced connector may be used as an Input ONLY when connected to a McIntosh C1000 Preamplifier. For all other connections use only as an Output.



How to Connect

Caution: The supplied AC Power Cord should not be connected to the Rear Panel of the MC2301 Tube Power Amplifier until after the Loudspeaker Connections have been made. Failure to observe this could result in Electric Shock. For additional instruction on making Loudspeaker Connections contact your McIntosh Dealer or McIntosh Technical Support.

1. For Remote Power Control, connect a power control cable from the Control Center or Preamplifier Power Control Out to the MC2301 POWER CONTROL IN.
2. Connect a cable from the Balanced Output of a McIntosh Preamplifier or Control Center to the MC2301 BALANCED INPUT. Place the INPUT MODE Switch in the BALANCED Position.

Note: An optional hookup is to use an unbalanced cable and place the INPUT MODE Switch in the UNBALANCED Position.

When connecting Loudspeakers to the MC2301 it is very important to use cables of adequate size, so there is little to no power loss in the cables. The size is specified in Gauge Numbers or AWG (American Wire Gauge). The smaller the Gauge number, the larger the wire size:

Loudspeaker Cable Distance vs Wire Gauge Guide			
Loudspeaker Impedance	25 feet (7.62 meters) or less	50 feet (15.24 meters) or less	100 feet (30.48 meters) or less
2 Ohms	12AWG	10AWG	8AWG
4 Ohms	14AWG	12AWG	10AWG
8 Ohms	16AWG	14AWG	12AWG

3. This McIntosh MC2301 Tube Power Amplifier is designed for the connection of a single Loudspeaker with an impedance of 2 ohms, 4 ohms or 8 ohms.

Note: The remaining Loudspeaker Terminals on the Amplifier should not be connected to another Loudspeaker.

4. Prepare the Loudspeaker Hookup Cables that attach to the Amplifier by choosing one of the methods below:

Bare wire cable ends:

Carefully remove sufficient insulation from the cable ends, refer to figures 1, 2 & 3. If the cable is stranded, carefully twist the strands together as tightly as possible.

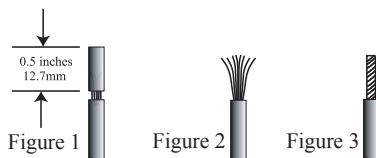

Note: If desired, the twisted ends can be tinned with solder to keep the strands together, or attach spade lug and/or banana connector.

Spade lug or prepared wire connection:

Insert the spade lug connector or prepared section of the cable end into the terminal side access hole, and tighten the terminal cap until the cable is firmly clamped into the terminal so the wires cannot slip out. Refer to figures 4, 5 & 6.

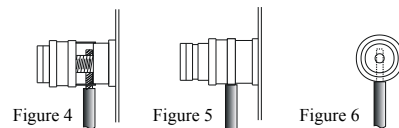

Banana plug connection:

Insert the banana plug into the hole at the top of the terminal. Refer to figures A and B.

Note: Banana Plugs are for use in the United States and Canada only.

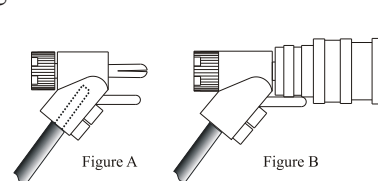

When making Loudspeaker Connections to the MC2301 refer to the Connection Diagram on the next page. This is an example of a typical audio system, your system may vary from this, however the actual Loudspeaker would be connected in a similar manner.

5. Connect the Loudspeaker hookup cables from a single Loudspeaker to the output terminals that match the impedance of the Loudspeaker, being careful to observe the correct polarities. Output impedance connections of 2 ohms, 4 ohms and 8 ohms are provided. If the Loudspeaker's impedance is in-between the available connections, use the nearest lower impedance connection.

WARNING: Loudspeaker terminals are hazardous live and present a risk of electric shock.

6. Connect the MC2301 Power Cord to a live AC outlet.

McIntosh Preamplifier

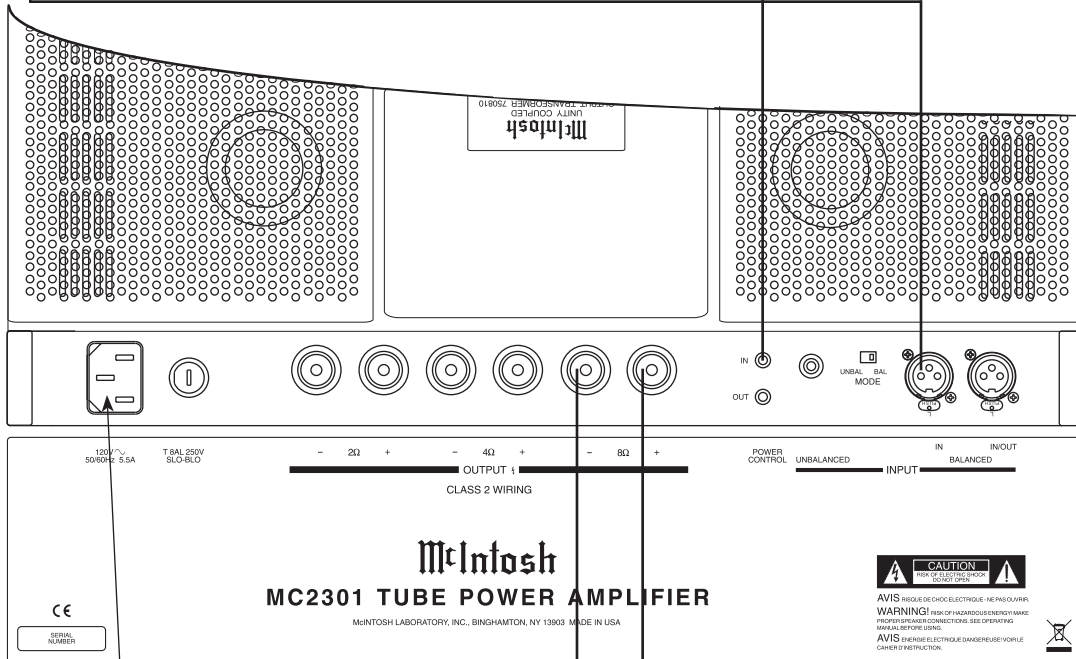
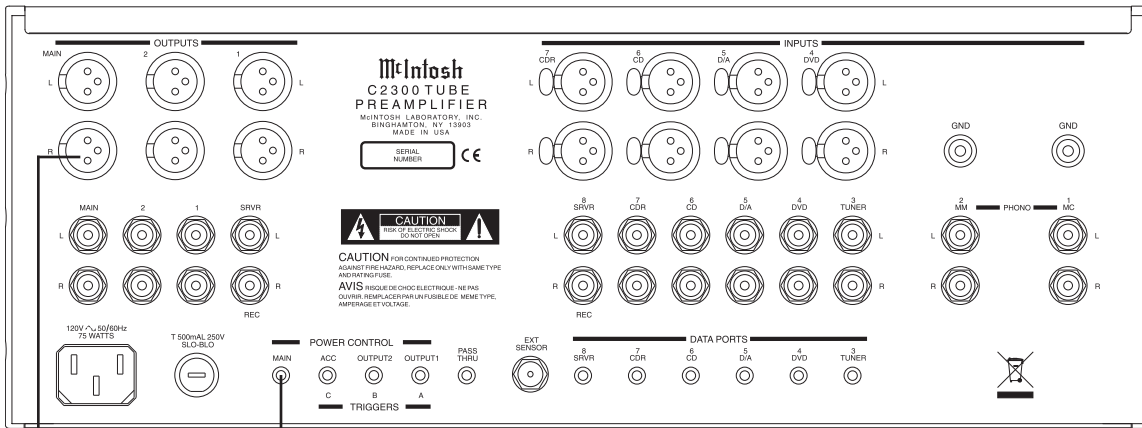

Connect to AC Outlet

McIntosh Loudspeaker

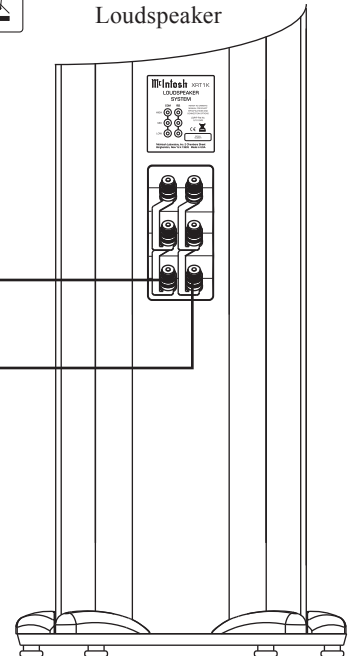



How to Connect for Bi-Amp

Caution: The supplied AC Power Cord should not be connected to the Rear Panel of the MC2301 Tube Power Amplifier until after the Loudspeaker Connections have been made. Failure to observe this could result in Electric Shock. For additional instruction on making Loudspeaker Connections contact your McIntosh Dealer or McIntosh Technical Support.

1. For Remote Power Control, connect a power control cable from the Control Center or Preamplifier Power Control Out to POWER CONTROL IN on the McIntosh MC2301 Power Amplifier.
2. Connect a power control cable from the McIntosh MC2301 Power Amplifier POWER CONTROL Out to the Power Control In on the McIntosh Power Amplifier Two.
3. Connect a cable from the Balanced Output of a McIntosh Preamplifier or Control Center to the BALANCED INPUT on the McIntosh MC2301 Power Amplifier.
4. Connect a cable from the BALANCED INPUT/OUTPUT of the McIntosh MC2301 Power Amplifier to the BALANCED INPUT on the McIntosh Power Amplifier Two. Place the MC2301 INPUT MODE Switch in the BALANCED Position.

When connecting Loudspeakers to the MC2301 it is very important to use cables of adequate size, so there is little to no power loss in the cables. The size is specified in Gauge Numbers or AWG (American Wire Gauge). The smaller the Gauge number, the larger the wire size:

Loudspeaker Cable Distance vs Wire Gauge Guide			
Loudspeaker Impedance	25 feet (7.62 meters) or less	50 feet (15.24 meters) or less	100 feet (30.48 meters) or less
2 Ohms	12AWG	10AWG	8AWG
4 Ohms	14AWG	12AWG	10AWG
8 Ohms	16AWG	14AWG	12AWG

5. This McIntosh MC2301 Tube Power Amplifier is designed for the connection of a single Loudspeaker with an impedance of 2 ohms, 4 ohms or 8 ohms.

Note: The remaining Loudspeaker Terminals on the Amplifier should not be connected to another Loudspeaker.

6. Prepare the Loudspeaker Hookup Cables that attach to the Amplifier by choosing one of the methods below:

Bare wire cable ends:

Carefully remove sufficient insulation from the cable ends, refer to figures 1, 2 &

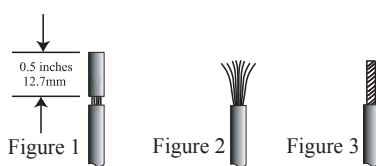

3. If the cable is stranded, carefully twist the strands together as tightly as possible.

Note: If desired, the twisted ends can be tinned with solder to keep the strands together, or attach spade lug and/or banana connector.

Spade lug or prepared wire connection:

Insert the spade lug connector or prepared section of the cable end into the terminal side access hole, and tighten the terminal cap until the cable is firmly clamped into the terminal so the wires cannot slip out. Refer to figures 4, 5 & 6.

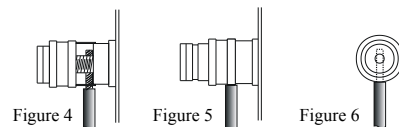

Banana plug connection:

Insert the banana plug into the hole at the top of the terminal. Refer to figures A and B.

Note: Banana Plugs are for use in the United States and Canada only.

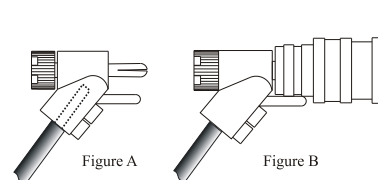

When making Loudspeaker Connections to the MC2301 refer to the Connection Diagram on the next page. This is an example of a typical audio system, your system may vary from this, however the actual Loudspeaker would be connected in a similar manner.

7. Connect the Loudspeaker hookup cables from a single Loudspeaker to the output terminals that match the impedance of the Loudspeaker, being careful to observe the correct polarities. Output impedance connections of 2 ohms, 4 ohms and 8 ohms are provided. If the Loudspeaker's impedance is in-between the available connections, use the nearest lower impedance connection.

WARNING: Loudspeaker terminals are hazardous live and present a risk of electric shock.

8. Connect the MC2301 Power Cord to a live AC outlet.

McIntosh Preamp

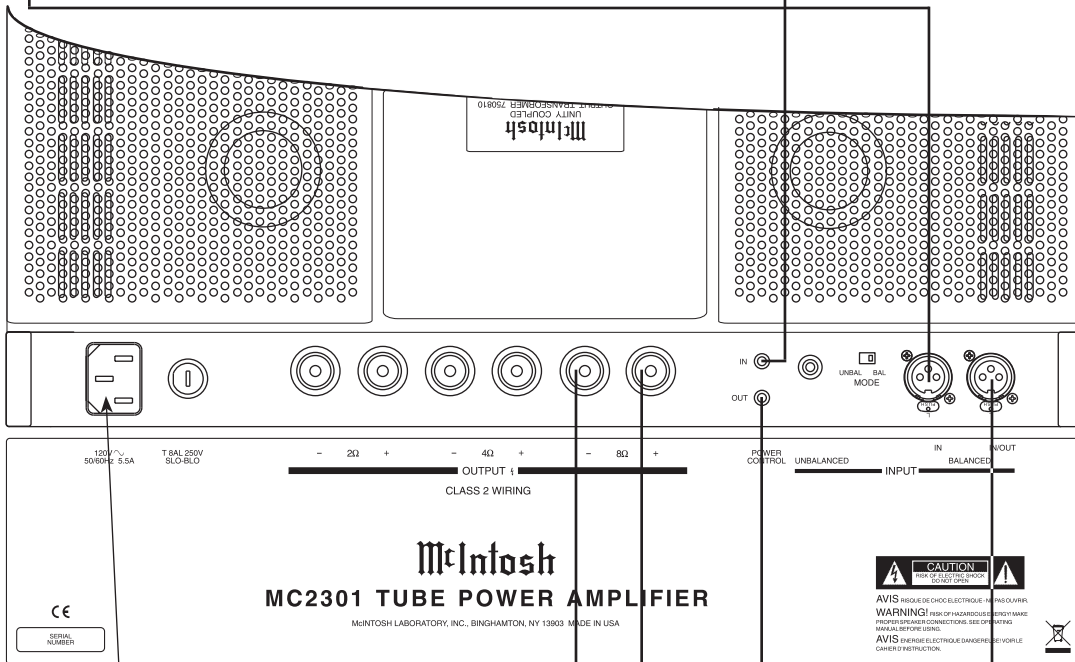
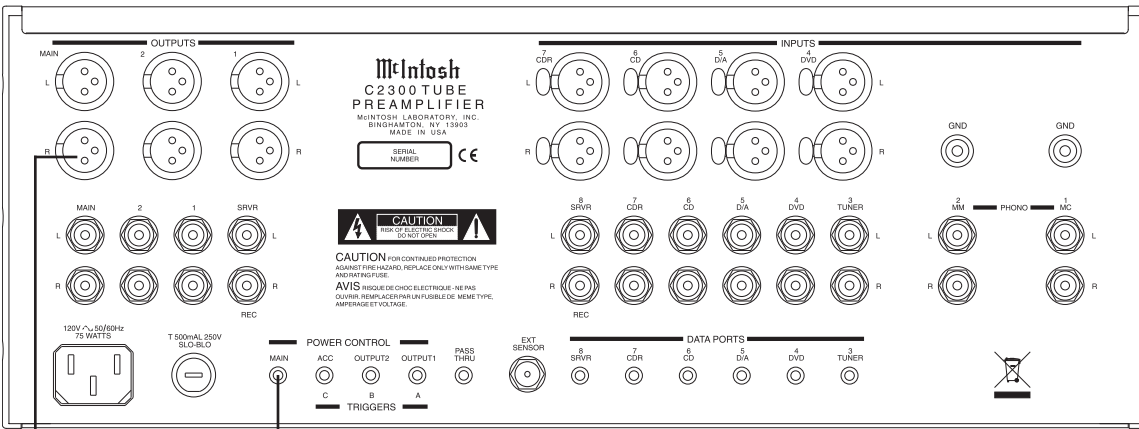

Connect to AC Outlet

McIntosh Power Amplifier Two

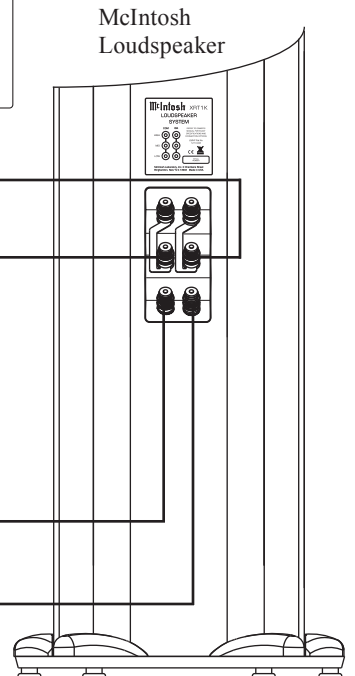
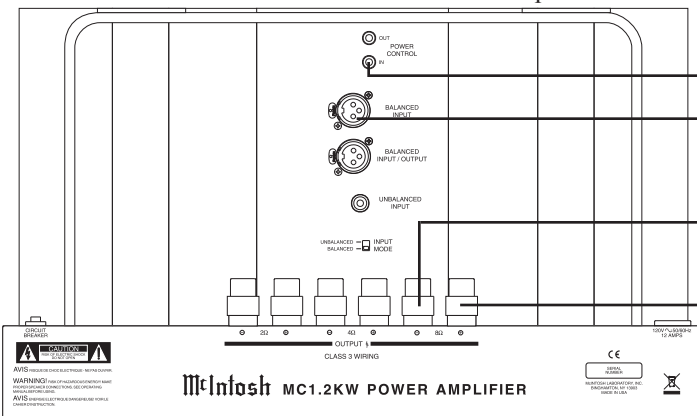



Meter indicates the Power Output of the Amplifier

Standby Power On and Sentry Monitor Tube Protection Activation Indicator

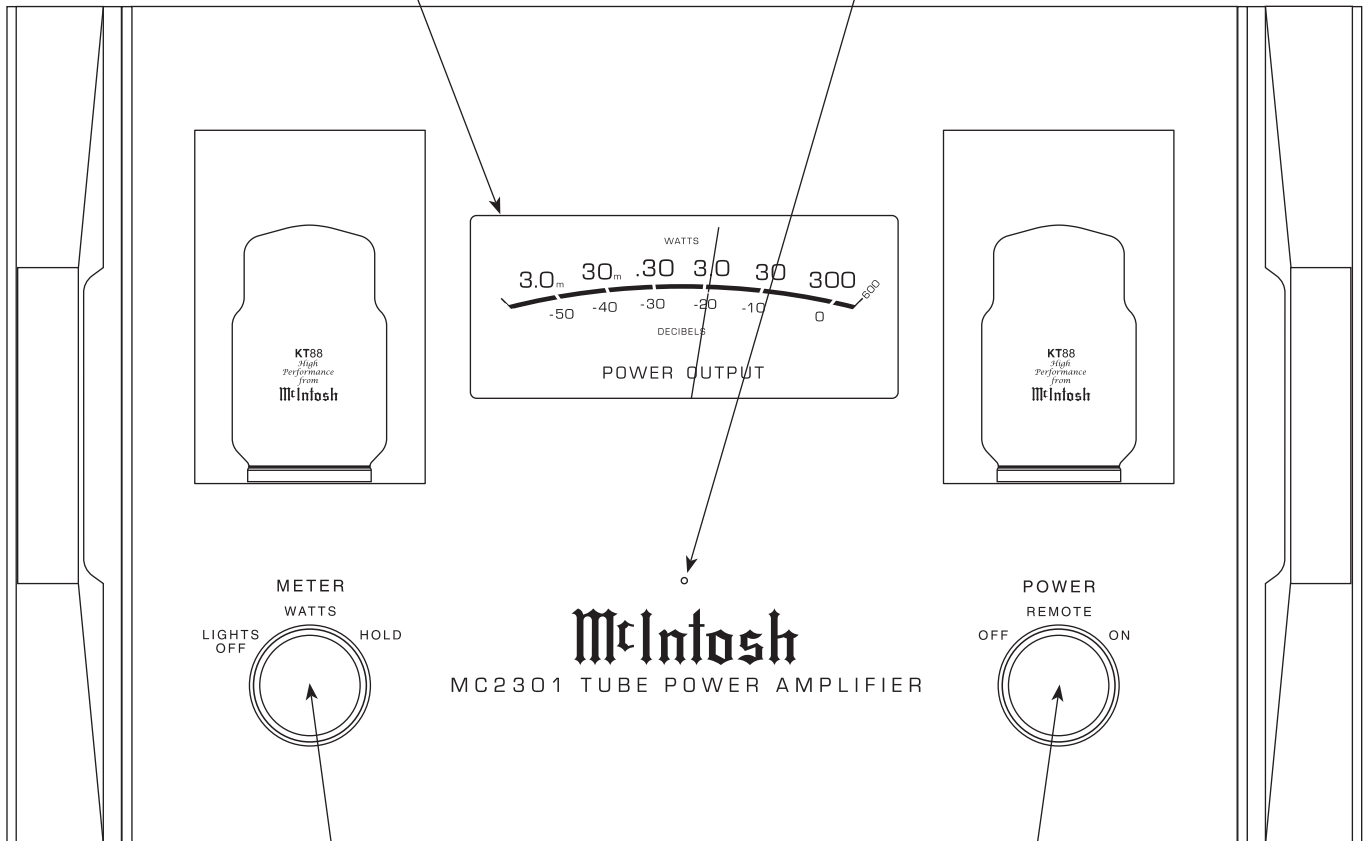

METER Switch selects the display modes of the Power Output Meter and Meter Illumination

POWER Switch Turns AC Power On/Off, or On/Remote

How to Operate

Power On

To have the MC2301 automatically turn On or Off when a control center turns on or off, rotate the power switch to the remote position. For manual operation, rotate the power switch to the On or Off position as desired. Refer to figure 8.

Note: There must be a power control connection between the MC2301 and the McIntosh Control Center, in order for the remote power turn-on to function.

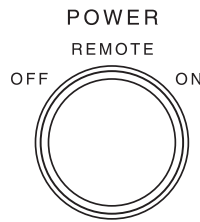

Figure 8

Meter Selection

Rotate the meter mode switch to select the meter operation mode you desire. Refer to figures 9 and 10.

Lights Off - Meter lights are turned off and the meter will continue to indicate the power output.

Note: When Power

Control Input of the MC2301 is connected to a McIntosh A/V Control Center or Preamplifier with Remote Meter Illumination Control, the Meter Illumination will automatically be remotely controlled (On/Off) with the METER Switch set to the WATTS or HOLD position.

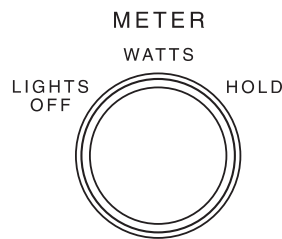

Figure 9

Watts - The meter responds to all the musical information being produced by the amplifier. It indicates to an accuracy of at least 95% of the power output with only a single cycle of a 2000Hz tone burst.

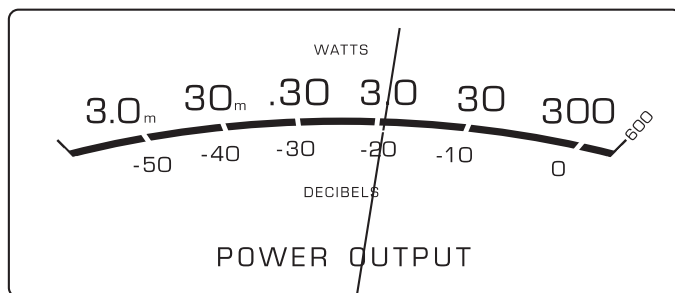

Figure 10

Hold - The meter pointer is locked to the highest power peak in a sequence of peaks. It is electronically held to this power level until a higher power peak passes through the

amplifier. The meter pointer will then rise to the newer higher indication. If no further power peaks are reached, the meter pointer will very slowly return to its rest position or lower power level. The decay rate is approximately 6dB per minute.

Input Mode Switch

The Input Mode Switch, which is located on the Rear Panel of the MC2301, allows you to select either the BAL (Balanced) or UNBAL (Unbalanced) Input. Refer to figure 11.

Standby/Protection Indicator

The MC2301 Sentry Monitor Tube Protection Circuitry provides protection to the Power Amplifier in the event of an impedance mismatch¹ between the MC2301 and the Loudspeaker. It will also activate if there is a short circuit at the MC2301 Output Terminals (or the Loudspeaker Terminals) or if a MC2301 Power Output Tube should fail. During normal operation the Sentry Monitor Tube Protection Circuitry has no effect on the performance of the Power Amplifier.

In the event a problem occurs, the MC2301 Sentry Monitor Tube Protection Circuitry will activate to prevent potentially destructive high levels of current from flowing in the amplifier. The Front Panel Standby LED will start flashing indicating the Protection Circuitry is active. Refer to the illustration on page 16 for the location of Standby LED.

To reset the Sentry Monitor Tube Protection Circuitry place the POWER Switch to the OFF position. After waiting approximately one minute, place the POWER Switch to the REMOTE or ON position.

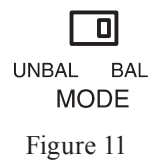

Figure 11

¹ This can occur when a Loudspeaker of a given impedance rating is connected to the MC2301 Output Terminals with a different impedance rating. For example, a Loudspeaker with an impedance rating of 2 Ohm is connected the MC2301 8 Ohm Output Terminals. The impedance of a Loudspeaker actually varies as the Loudspeaker reproduces different frequencies. As a result, the nominal impedance rating of the Loudspeaker (usually measured at a midrange frequency) might not always agree with the impedance of the Loudspeaker at low frequencies where the greatest amount of power is required.



Technical Description

McIntosh Laboratory, the company who introduced the world's first amplifier that could be called "High Fidelity", has done it again. The McIntosh engineering staff has created a tube power amplifier without compromise, using the most advanced McIntosh circuit design concepts.

A continuous average power output rating of 300 watts makes this not only the most advanced, but also one of the most powerful tube amplifiers McIntosh has ever manufactured. The distortion limits for the MC2301 are no more than 0.5% at rated power output for all frequencies from

20Hz to 20,000Hz. Typical performance at mid frequencies is less than 0.05%. The MC2301 can deliver the best possible performance from any type of high quality loud-speaker system.

Creating a tube amplifier with this level of performance did not come easily. Many months of design, testing and measuring were required. Extensive controlled listening tests, the ultimate form of measuring, were made before the final design was accepted.



Top View of the MC2301

MC2301 Design

The design philosophy incorporated in the MC2301 involved several different techniques, all based on sound scientific logic. Every stage of voltage amplification must be as linear as possible prior to the use of negative feedback.

McIntosh engineers know how to properly design negative feedback circuits so they contribute to the low distortion performance expected from a McIntosh amplifier. Refer to figure 12. The typical McIntosh owner would never accept the approximately 25 times higher distortion of many non-

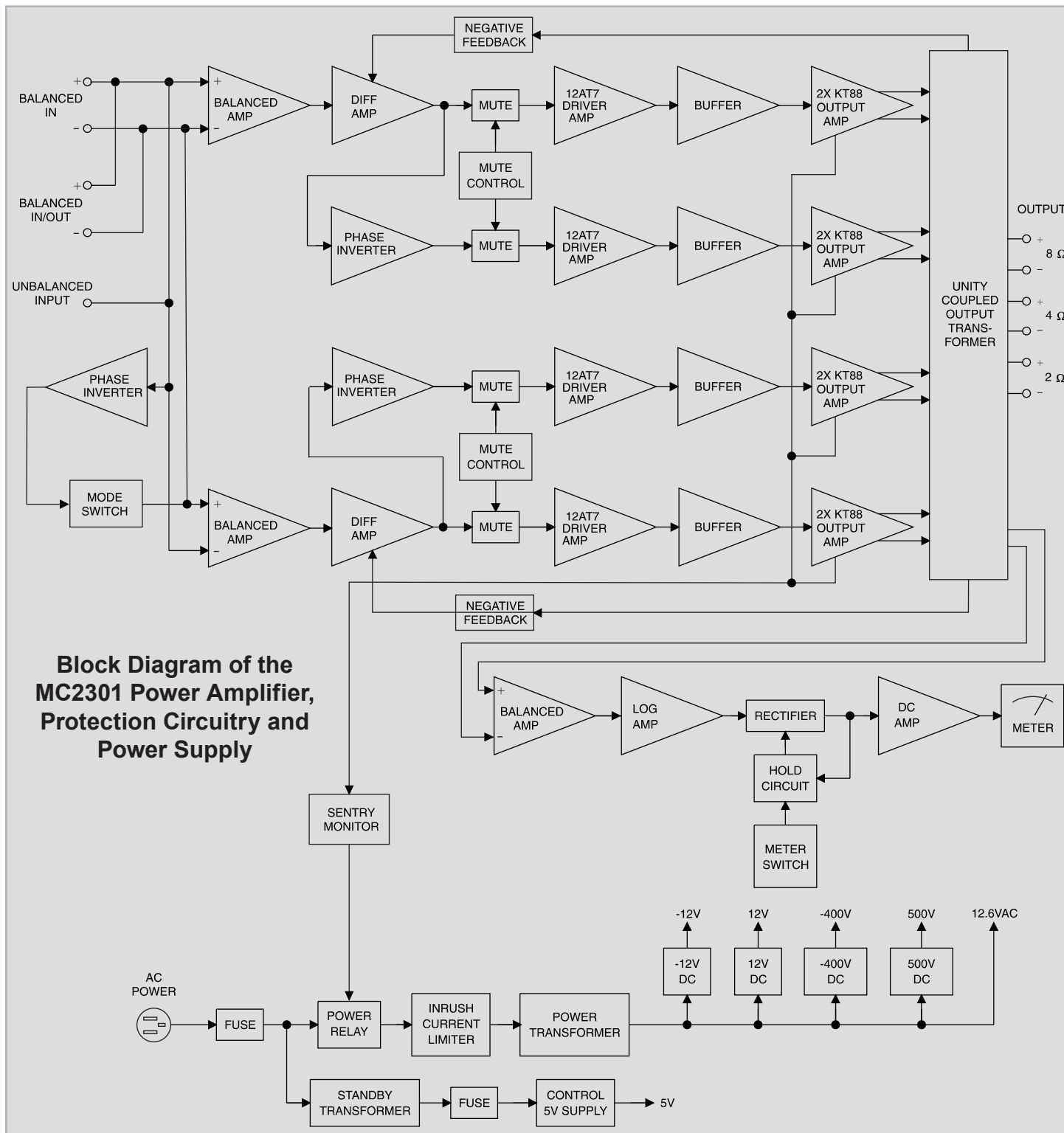

Figure 12

Technical Description, con't

feedback designs.

The fully Balanced Push-Pull design is used from input to output. The resulting fully balanced configuration cancels many forms of audible distortion and greatly improves the Signal-to-Noise ratio of the amplifier.

While conventional designs only take output from the plate, the Patented Unity Coupled Power Amplifier Circuitry takes the Power Output from both the plate and cathode of the Power Output Tubes. This allows for only one half of the turns ratio in the Output Transformer used in conventional designs. The result is much lower distortion, wider bandwidth and increased loudspeaker damping factor. Refer to figure 13.



Figure 13

The output signals of the two matched Patented Unity Coupled Circuit Power Amplifiers operate in a push-pull balanced circuit and are coupled together in the unique McIntosh MC2301 Dual Core Output Transformer. Refer to figure 14. It provides low distortion power transfer at frequencies from below 20Hz to well beyond 20,000Hz with optimum impedance points of two ohms, four ohms and eight ohms. The unequalled expertise of McIntosh in the design and manufacturing of transformers is legendary in the high fidelity industry.

Precision metal film resistors and low dielectric absorption film capacitors



Figure 14

are used in all critical circuit locations. The circuit design of the MC2301 contributes to low operating temperatures using convection cooling. No fans are needed.

Power Output Meter

The McIntosh MC2301 has a large Output Watt Meter that responds 95% full scale to a single cycle tone burst at 2kHz. Refer to figure 15. The voltage outputs are electronically measured and fed to a special circuit that accelerates the pointer movement in the upward direction. When the pointer reaches its peak it pauses only long enough for the human eye to perceive its position, then drops.

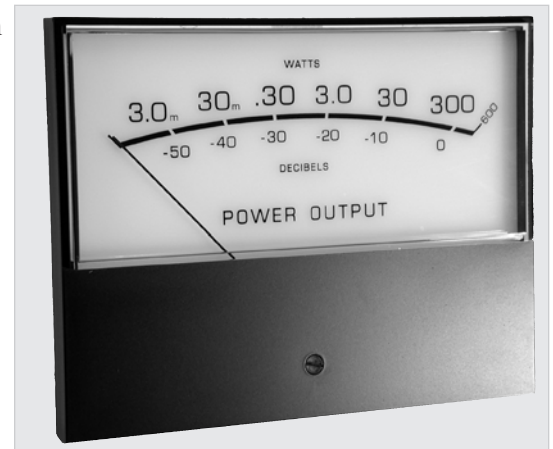

Figure 15

It is almost 10 times faster than a professional VU meter.

A front panel switch is provided to change the meter to the Watts Hold Mode of operation. This allows fast upward movement of the pointer but greatly increases Hold Time at the peak of its travel. The highest power output of the source material is thus recorded.

Sentry Monitor Protection Circuit

The MC2301 incorporates the newly designed Sentry Monitor Tube Protection Circuitry. Refer to figure 16. This circuit provides protection to the Power Amplifier in the event of an improper load (mismatched impedance), shorted loudspeaker cable or if a Power Output Tube

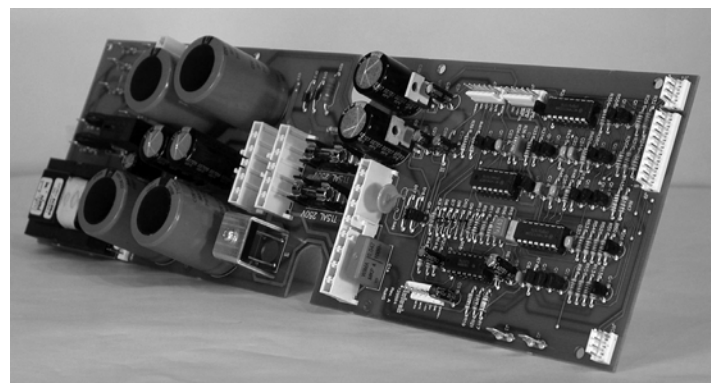

Figure 16

should fail. During normal operation there is absolutely no compromise in sonic performance with this circuit, and it ensures safe operation of the amplifier under even the most extreme operating conditions.

In the event a problem occurs, the MC2301 Sentry Monitor Tube Protection Circuitry will activate to prevent potentially destructive high levels of current from flowing in the amplifier.

Power Supply Circuits

To compliment the fully balanced design of the MC2301 the power supply utilizes a very large Power Transformer (golf ball is for size comparison). Refer to figure 17. It is

the next power amplifier occurs at a later time. This helps prevent power circuit overload that could trip circuit breakers or blow fuses, a very important feature in a high power Home Theater System employing multiple MC2301 Power



Figure 17

enclosed in the legendary McIntosh Potted Enclosures. The main filter capacitors store energy necessary for the wide dynamic range that today's Audio demands. Refer to figure 16.

Most owners desire one power switch for the whole audio system. The MC2301 is equipped with a circuit that provides remote Power Control from a McIntosh A/V Control Center. When the A/V Control Center is switched On, a (5-12V) signal operates the power relay in the MC2301. The MC2301 also has a remote Power Control Out Jack. The Power Control signal from this jack is delayed by a fraction of a second so that the turn on power surge of



Specifications

Power Output

Minimum sine wave continuous average power output is:
300 watts into 2 ohm load
300 watts into 4 ohm load
300 watts into 8 ohm load

Output Load Impedance

2, 4 or 8 ohms

Rated Power Band

20Hz to 20,000Hz

Total Harmonic Distortion

0.5% maximum harmonic distortion at any power level from 250 milliwatts to rated power, 20Hz to 20,000Hz

Frequency Response

+0, -0.5dB from 20Hz to 20,000Hz
+0, -3.0dB from 10Hz to 100,000Hz

Input Sensitivity (for rated output)

1.7 Volt Unbalanced
3.4 Volt Balanced

Signal To Noise Ratio (A-Weighted)

117dB below rated output

Intermodulation Distortion

0.5% maximum, if the instantaneous peak power output does not exceed twice the rated power output for any combination of frequencies from 20Hz to 20,000Hz.

Wide Band Damping Factor

Greater than 15

Input Impedance

47,000 ohms

Tube Compliment

2 - 12AT7 Voltage Amplifier
8 - KT88 or 6550 Power Output

Power Requirements

100 Volts, 50/60Hz at 6.6 Amps
110 Volts, 50/60Hz at 6 Amps
120 Volts, 50/60Hz at 5.5 Amps
220 Volts, 50/60Hz at 3 Amps
230 Volts, 50/60Hz at 2.75 Amps
240 Volts, 50/60Hz at 2.75 Amps
Standby: 1 watt

Note: Refer to the rear panel of the MC2301 for the correct voltage.

Overall Dimensions

Width is 17-3/4 inches (45.09cm)
Height is 12-5/16 inches (31.27cm) including feet
Depth is 23 inches (58.42cm) including the Front Panel and Cables

Weight

116 pounds (52.6 kg) net, 141 pounds (63.9 kg) in shipping carton

Shipping Carton Dimensions

Width is 31 inches (78.74cm)
Depth is 28 inches (71.12cm)
Height is 17-1/4 inches (43.82cm)

Packing Instructions

In the event it is necessary to repack the equipment for shipment, the equipment must be packed exactly as shown below. It is very important that the four feet are attached to the bottom of the equipment. This will ensure the proper equipment location on the bottom foam pad. Failure to do this will result in shipping damage.

To protect the tubes during shipment, the two Foam Inserts removed from the MC2301 need to be re-inserted. Follow the unpacking instructions on pages 3-4 in the reverse order.

Use the original shipping carton and interior parts only if they are all in good serviceable condition. If a shipping carton or any of the interior part(s) are needed, please call or write Customer Service Department of McIntosh Laboratory, refer to page 3. Please see the Part List for the correct part numbers.

Quantity	Part Number	Description
1	034105	Shipping carton top
1	034104	Shipping carton bottom
2	034439	Foam Pad (top and bottom)
3	034441	Foam Ring
2	034440	Foam Inserts (for protecting the Tubes during shipping)
1	0410900	Warning Sheet
4	400159	10-32 x 3/4 inch screw
4	018445	Feet

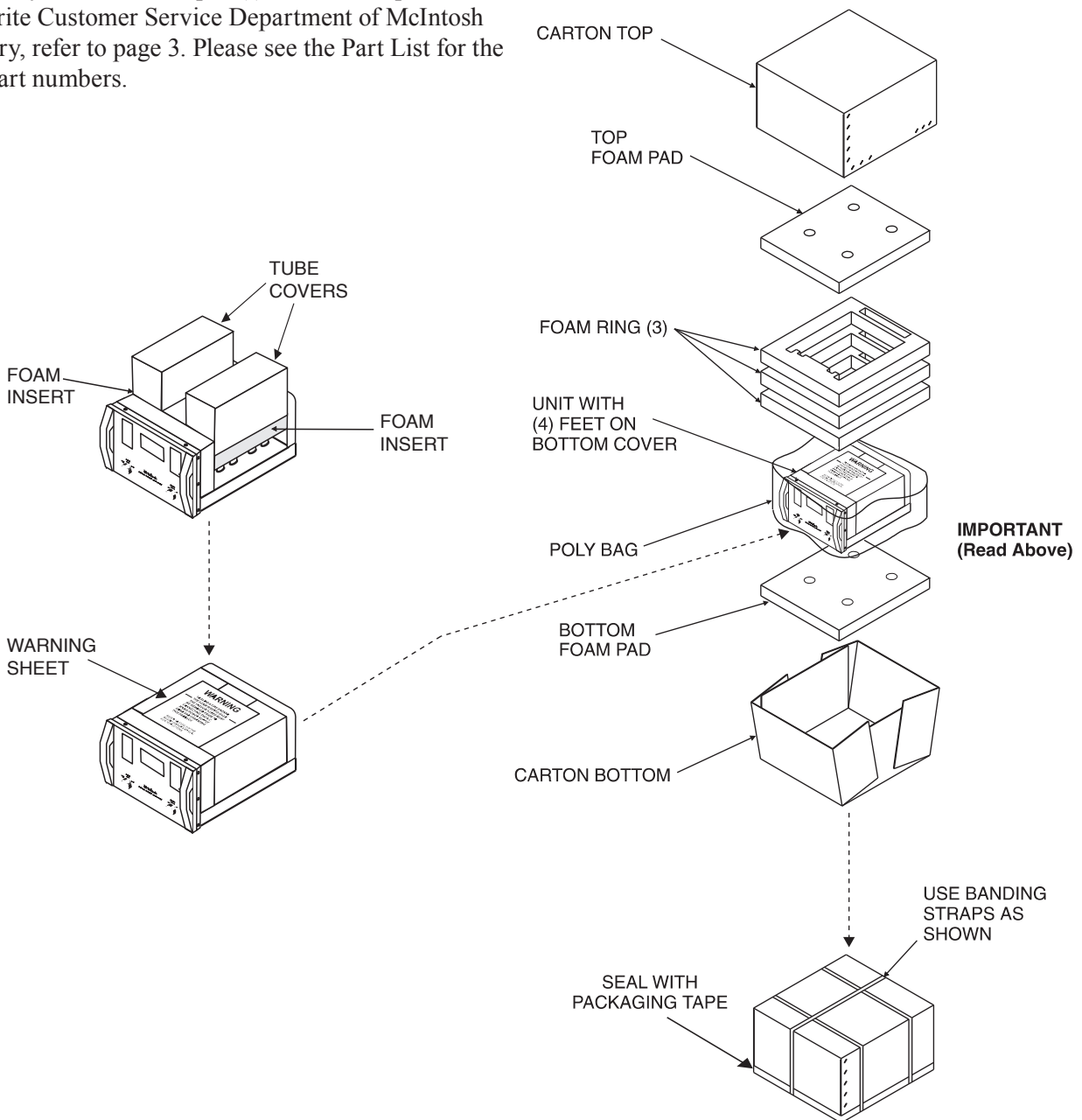



McIntosh Laboratory, Inc.
2 Chambers Street
Binghamton, NY 13903

The continuous improvement of its products is the policy of McIntosh Laboratory Incorporated who reserve the right to improve design without notice. Printed in the U.S.A.

McIntosh Part No. 04108500